



BF547

NPN 1 GHz wideband transistor

Rev. 03 — 27 July 2004

Product data sheet

1. Product profile

1.1 General description

Low cost NPN transistor in a SOT23 plastic package.

1.2 Features

- Feedback capacitance typically 1 pF
- Stable oscillator operation
- High current gain
- Good thermal stability.

1.3 Applications

- Intended for VHF and UHF TV-tuner applications and can be used as a mixer and/or oscillator.

1.4 Quick reference data

Table 1: Quick reference data

Symbol	Parameter	Conditions	Min	Typ	Max	Unit
V_{CEO}	collector-emitter voltage	open base	-	-	20	V
V_{CBO}	collector-base voltage	open emitter	-	-	30	V
V_{EBO}	emitter-base voltage	open collector	-	-	3	V
I_{CM}	peak collector current		-	-	50	mA
P_{tot}	total power dissipation	$T_s \leq 70\text{ °C}$	[1]	-	300	mW
f_T	transition frequency	$I_C = 15\text{ mA};$ $V_{CE} = 10\text{ V};$ $f = 500\text{ MHz}$	1.2	-	1.6	GHz
C_{re}	feedback capacitance	$I_E = i_e = 0\text{ A};$ $V_{CB} = 10\text{ V};$ $f = 1\text{ MHz}$	1	-	-	pF

[1] T_s is the temperature at the soldering point of the collector pin.

PHILIPS

2. Pinning information

Table 2: Discrete pinning

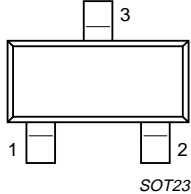
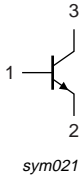
Pin	Description	Simplified outline	Symbol
1	base		
2	emitter		
3	collector		

3. Ordering information

Table 3: Ordering information

Type number	Package		
	Name	Description	Version
BF547	-	plastic surface mounted package; 3 leads	SOT23

4. Marking

Table 4: Marking

Type number	Marking code ^[1]
BF547	23*

[1] * = p: Made in Hong Kong.

* = t: Made in Malaysia.

* = W: Made in China.

5. Limiting values

Table 5: Limiting values

In accordance with the Absolute Maximum Rating System (IEC 60134).

Symbol	Parameter	Conditions	Min	Max	Unit
V_{CEO}	collector-emitter voltage	open base	-	20	V
V_{CBO}	collector-base voltage	open emitter	-	30	V
V_{EBO}	emitter-base voltage	open collector	-	3	V
I_{CM}	peak collector current		-	50	mA
P_{tot}	total power dissipation	$T_s \leq 70\text{ °C}$	^[1] -	300	mW
T_{stg}	storage temperature		-65	+150	°C
T_j	junction temperature		-	150	°C

[1] T_s is the temperature at the soldering point of the collector pin.

6. Thermal characteristics

Table 6: Thermal characteristics

Symbol	Parameter	Conditions	Typ	Unit
$R_{th(j-s)}$	thermal resistance from junction to soldering point	$T_s \leq 70\text{ °C}$	[1] 260	K/W

[1] T_s is the temperature at the soldering point of the collector pin.

7. Characteristics

Table 7: Characteristics

$T_j = 25\text{ °C}$ unless otherwise specified.

Symbol	Parameter	Conditions	Min	Typ	Max	Unit
I_{CBO}	collector cut-off current	$I_E = 0\text{ A}; V_{CB} = 10\text{ V}$	-	-	100	nA
h_{FE}	DC current gain	$I_C = 2\text{ mA}; V_{CE} = 10\text{ V}$	40	95	250	
f_T	transition frequency	$I_C = 15\text{ mA}; V_{CE} = 10\text{ V}; f = 500\text{ MHz}$	0.8	1.2	1.6	GHz
C_{re}	feedback capacitance	$I_E = i_e = 0\text{ A}; V_{CB} = 10\text{ V}; f = 1\text{ MHz}$	-	1	-	pF
G_{UM}	maximum unilateral power gain	$I_C = 15\text{ mA}; V_{CE} = 10\text{ V}; f = 100\text{ MHz}$	[1] -	20	-	dB

[1] G_{UM} is the maximum unilateral power gain, assuming s_{12} is zero and

$$G_{UM} = 10 \log \frac{|s_{21}|^2}{(1 - |s_{11}|^2)(1 - |s_{22}|^2)} \text{ dB} .$$

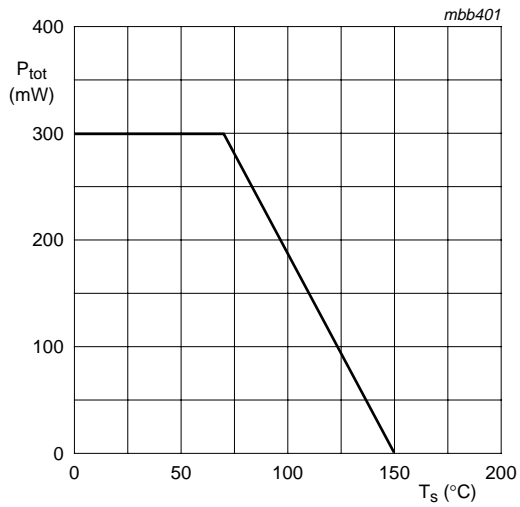
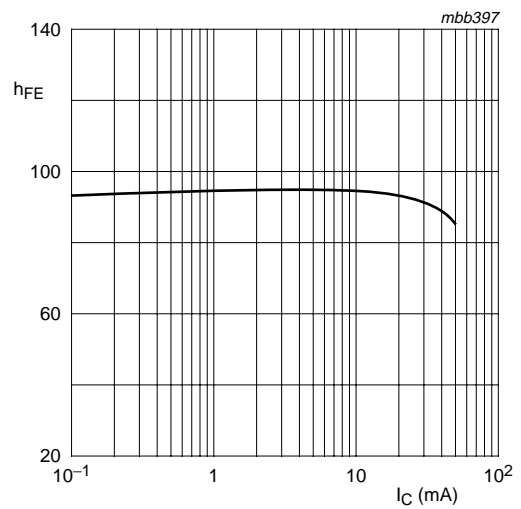
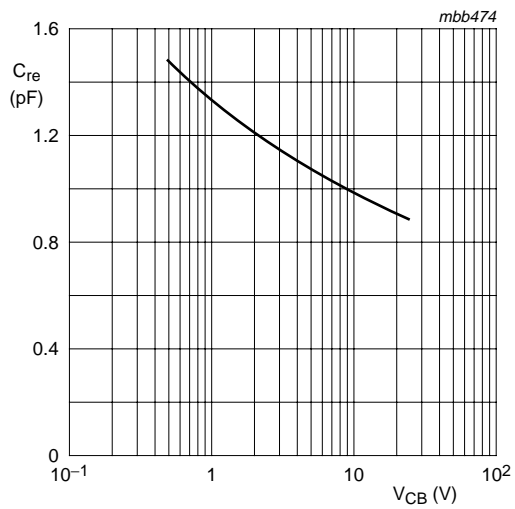

Fig 1. Power derating curve.



$V_{CE} = 10$ V.

Fig 2. DC current gain as a function of collector current.



$I_E = I_C = 0$ A; $f = 1$ MHz.

Fig 3. Feedback capacitance as a function of collector-base voltage.

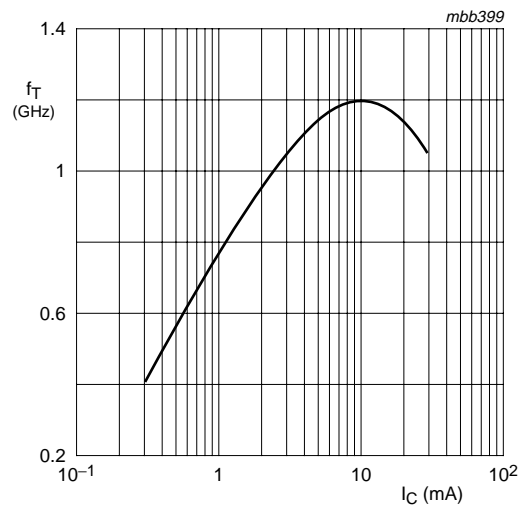

$V_{CE} = 10$ V; $f = 500$ MHz.

Fig 4. Transition frequency as a function of collector current.

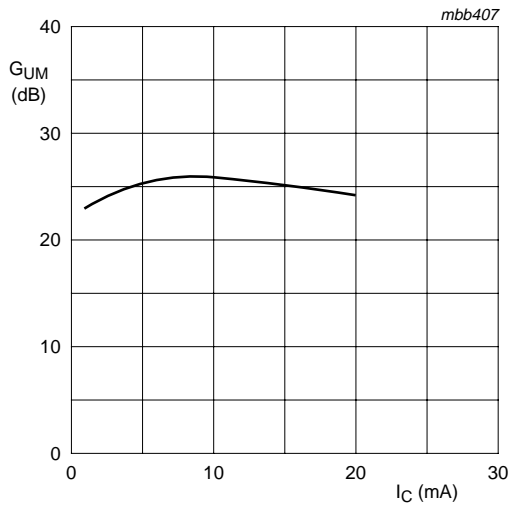

$V_{CE} = 10$ V; $f = 100$ MHz.

Fig 5. Maximum unilateral power gain as a function of collector current.

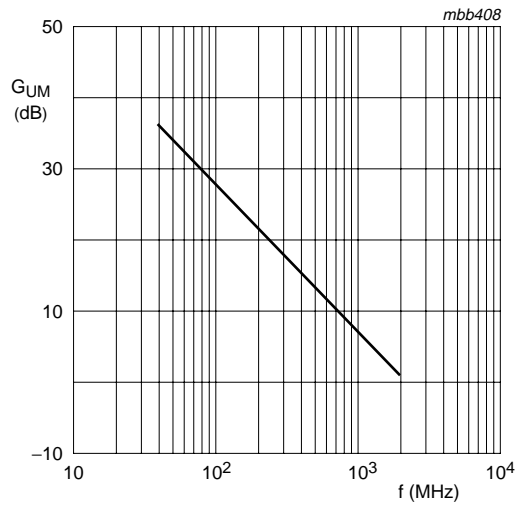

$I_C = 15$ mA; $V_{CE} = 10$ V.

Fig 6. Maximum unilateral power gain as a function of frequency.

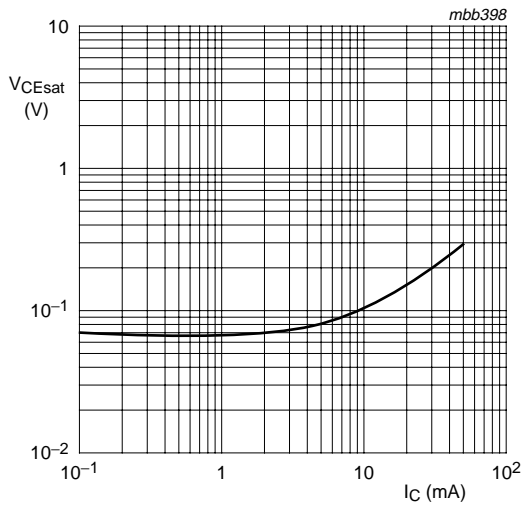

$I_C/I_B = 10$.

Fig 7. Collector-emitter saturation voltage as a function of collector current.

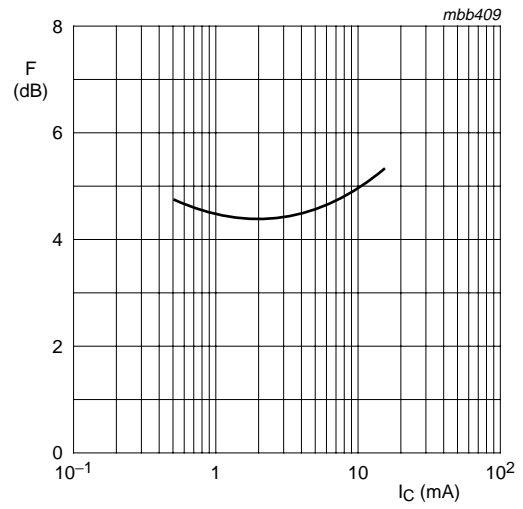

$V_{CE} = 10$ V; $Z_S = Z_L = 50$ Ω ; $f = 100$ MHz.

Fig 8. Common emitter noise figure as a function of collector current.

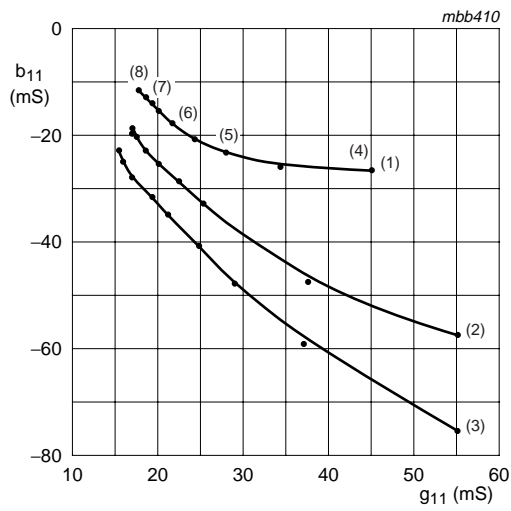

- $V_{CB} = 10$ V.
- (1) $I_E = -2$ mA.
 - (2) $I_E = -5$ mA.
 - (3) $I_E = -10$ mA.
 - (4) $f = 200$ MHz.
 - (5) $f = 400$ MHz.
 - (6) $f = 600$ MHz.
 - (7) $f = 800$ MHz.
 - (8) $f = 1000$ MHz.

Fig 9. Common base input admittance (Y_{11}).

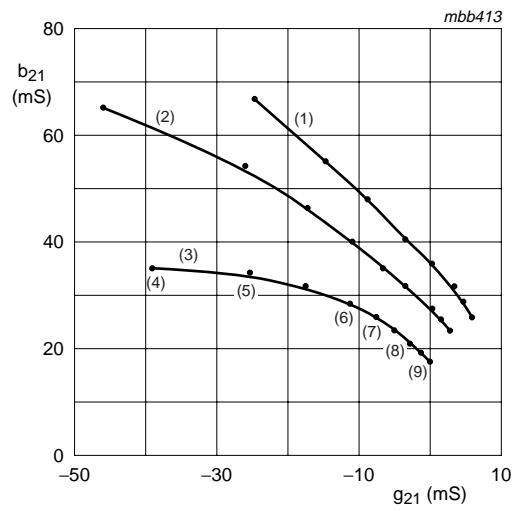

- $V_{CB} = 10$ V.
- (1) $I_E = -10$ mA.
 - (2) $I_E = -5$ mA.
 - (3) $I_E = -2$ mA.
 - (4) $f = 200$ MHz.
 - (5) $f = 300$ MHz.
 - (6) $f = 500$ MHz.
 - (7) $f = 600$ MHz.
 - (8) $f = 800$ MHz.
 - (9) $f = 1000$ MHz.

Fig 10. Common base forward admittance (Y_{21}).

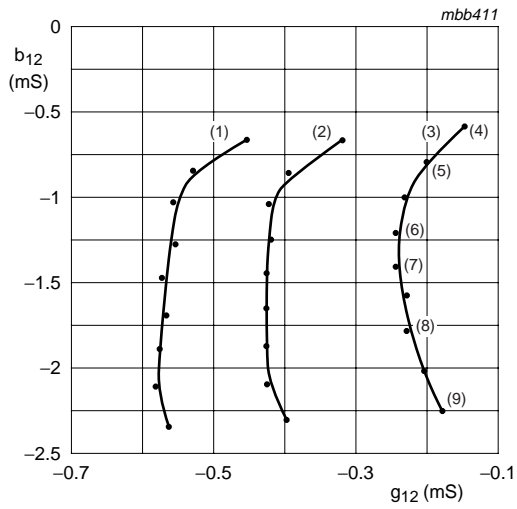

- $V_{CB} = 10 \text{ V.}$
- (1) $I_E = -10 \text{ mA.}$
 - (2) $I_E = -5 \text{ mA.}$
 - (3) $I_E = -2 \text{ mA.}$
 - (4) $f = 200 \text{ MHz.}$
 - (5) $f = 300 \text{ MHz.}$
 - (6) $f = 500 \text{ MHz.}$
 - (7) $f = 600 \text{ MHz.}$
 - (8) $f = 800 \text{ MHz.}$
 - (9) $f = 1000 \text{ MHz.}$

Fig 11. Common base reverse admittance (Y_{12}).

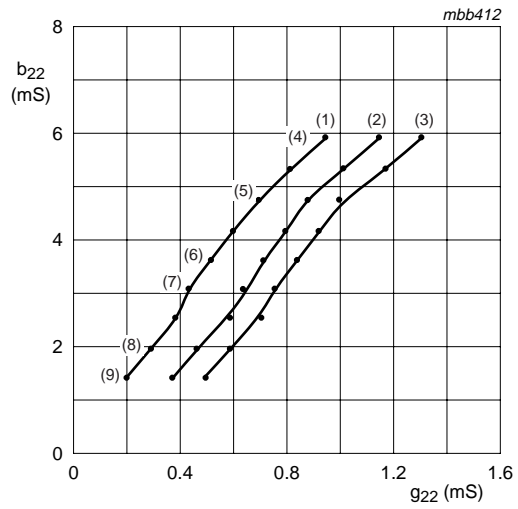

- $V_{CB} = 10 \text{ V.}$
- (1) $I_E = -2 \text{ mA.}$
 - (2) $I_E = -5 \text{ mA.}$
 - (3) $I_E = -10 \text{ mA.}$
 - (4) $f = 1000 \text{ MHz.}$
 - (5) $f = 800 \text{ MHz.}$
 - (6) $f = 600 \text{ MHz.}$
 - (7) $f = 500 \text{ MHz.}$
 - (8) $f = 300 \text{ MHz.}$
 - (9) $f = 200 \text{ MHz.}$

Fig 12. Common base output admittance (Y_{22}).

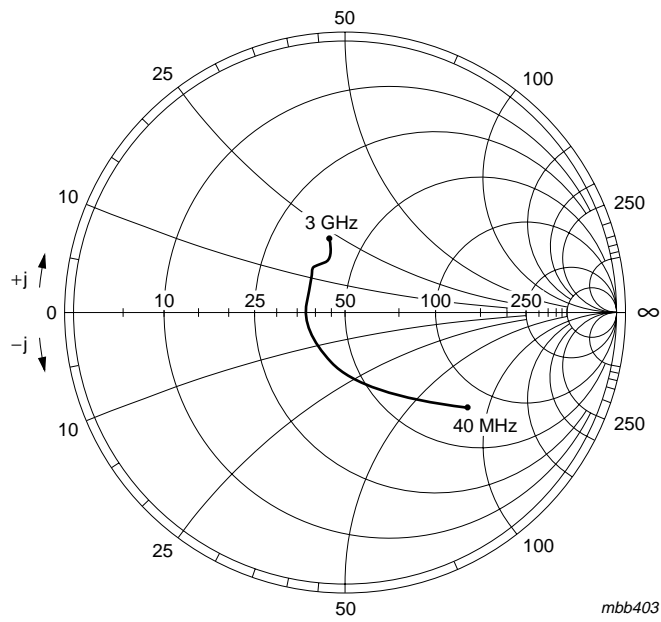

mbb403

$I_C = 15 \text{ mA}$; $V_{CE} = 10 \text{ V}$; $Z_O = 50 \Omega$.

Fig 13. Common emitter input reflection coefficient (S_{11}).

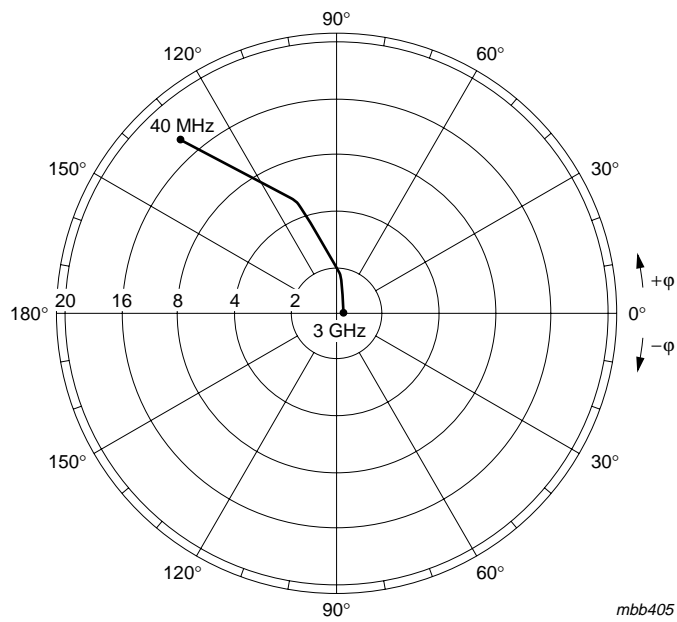

mbb405

$I_C = 15 \text{ mA}$; $V_{CE} = 10 \text{ V}$.

Fig 14. Common emitter forward transmission coefficient (s_{21}).

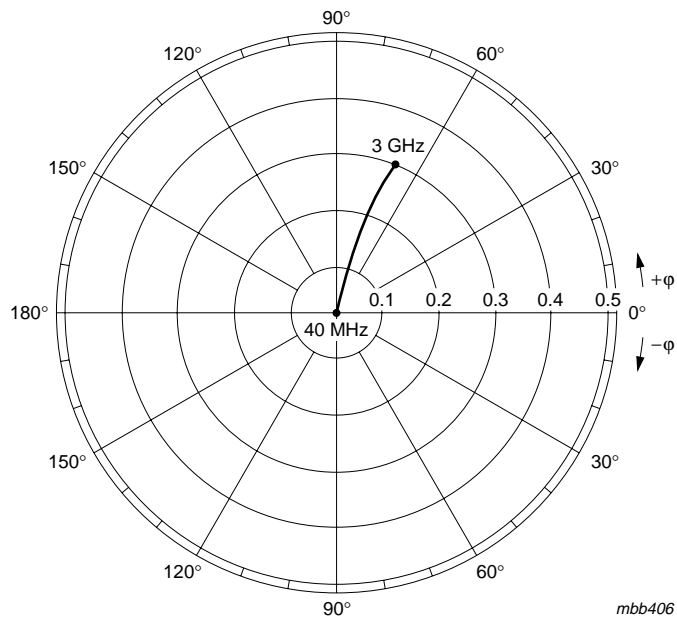

$I_C = 15 \text{ mA}; V_{CE} = 10 \text{ V}.$

Fig 15. Common emitter reverse transmission coefficient (s_{12}).

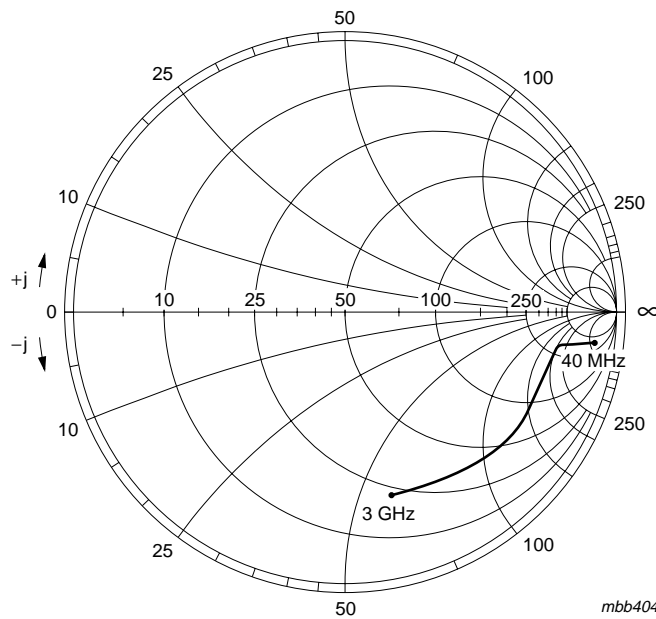

$I_C = 15 \text{ mA}; V_{CE} = 10 \text{ V}; Z_O = 50 \Omega.$

Fig 16. Common emitter output reflection coefficient (s_{22}).

Table 8: Common base Y-parameters; $V_{CB} = 10\text{ V}$; $I_E = -2\text{ mA}$

f (MHz)	Y ₁₁		Y ₂₁		Y ₁₂		Y ₂₂	
	REAL (mS)	IMAG. (mS)	REAL (mS)	IMAG. (mS)	REAL (mS)	IMAG. (mS)	REAL (mS)	IMAG. (mS)
40	+69.0	-10.2	-68.0	+12.3	-0.02	-0.1	-0.01	+0.3
100	+60.4	-20.6	-58.0	+25.6	-0.06	-0.3	-0.08	+0.7
200	+45.0	-27.4	-39.1	+34.5	-0.10	-0.6	+0.19	+1.4
300	+34.3	-26.4	-25.4	+34.0	-0.20	-0.8	+0.29	+1.9
400	+27.7	-23.3	-17.2	+31.1	-0.20	-1.0	+0.37	+2.5
500	+24.0	-20.4	-11.7	+27.6	-0.20	-1.2	+0.45	+3.0
600	+21.5	-18.0	-7.8	+25.0	-0.20	-1.4	+0.53	+3.6
700	+20.0	-15.6	-5.3	+22.6	-0.20	-1.6	+0.60	+4.2
800	+18.6	-14.0	-3.0	+20.2	-0.20	-1.8	+0.69	+4.7
900	+18.3	-12.8	-1.3	+18.7	-0.20	-2.0	+0.82	+5.3
1000	+17.8	-11.7	-0.1	+17.1	-0.20	-2.2	+0.95	+5.9

Table 9: Common base Y-parameters; $V_{CB} = 10\text{ V}$; $I_E = -5\text{ mA}$

f (MHz)	Y ₁₁		Y ₂₁		Y ₁₂		Y ₂₂	
	REAL (mS)	IMAG. (mS)	REAL (mS)	IMAG. (mS)	REAL (mS)	IMAG. (mS)	REAL (mS)	IMAG. (mS)
40	+132.6	-35.7	-130.5	+38.8	-0.06	-0.2	-0.06	+0.4
100	+96.3	-62.0	-91.1	+67.9	-0.20	-0.5	+0.21	+0.8
200	+54.7	-57.8	-46.0	+64.7	-0.30	-0.7	+0.38	+1.4
300	+37.5	-46.9	-26.4	+53.8	-0.40	-0.8	+0.47	+2.0
400	+29.2	-38.6	-16.6	+45.8	-0.40	-1.0	+0.58	+2.5
500	+25.3	-32.8	-11.0	+39.8	-0.40	-1.3	+0.63	+3.1
600	+22.0	-28.4	-6.3	+35.0	-0.40	-1.4	+0.71	+3.6
700	+20.3	-25.2	-3.3	+31.4	-0.40	-1.6	+0.80	+4.2
800	+18.7	-22.6	-0.6	+27.6	-0.40	-1.9	+0.88	+4.7
900	+17.8	-20.7	+1.4	+25.2	-0.40	-2.1	+1.01	+5.3
1000	+17.3	-19.1	+3.0	+23.0	-0.40	-2.3	+1.15	+6.0

Table 10: Common base Y-parameters; $V_{CB} = 10\text{ V}$; $I_E = -10\text{ mA}$

f (MHz)	Y ₁₁		Y ₂₁		Y ₁₂		Y ₂₂	
	REAL (mS)	IMAG. (mS)	REAL (mS)	IMAG. (mS)	REAL (mS)	IMAG. (mS)	REAL (mS)	IMAG. (mS)
40	+189.0	-79.6	-185.5	+83.0	-0.10	-0.3	-0.09	+0.4
100	+108.5	-99.0	-101.4	+105.4	-0.30	-0.5	+0.30	+0.9
200	+55.2	-76.2	-44.6	+82.8	-0.50	-0.7	+0.44	+1.4
300	+37.1	-59.0	-24.3	+65.7	-0.50	-0.9	+0.60	+2.0
400	+28.8	-47.6	-14.6	+54.4	-0.60	-1.0	+0.69	+2.5
500	+24.7	-40.2	-8.6	+46.7	-0.60	-1.3	+0.75	+3.1
600	+21.2	-35.0	-3.4	+40.8	-0.60	-1.5	+0.84	+3.6
700	+19.3	-31.0	-0.2	+36.2	-0.60	-1.7	+0.93	+4.2
800	+17.2	-27.5	+2.6	+31.1	-0.60	-1.9	+1.00	+4.7
900	+16.4	-25.2	+4.6	+28.3	-0.60	-2.1	+1.15	+5.3
1000	+15.8	-23.0	+6.0	+25.5	-0.60	-2.3	+1.31	+6.0

Table 11: Common base Y-parameters; $V_{CB} = 10\text{ V}$; $I_E = -15\text{ mA}$

f (MHz)	Y ₁₁		Y ₂₁		Y ₁₂		Y ₂₂	
	REAL (mS)	IMAG. (mS)	REAL (mS)	IMAG. (mS)	REAL (mS)	IMAG. (mS)	REAL (mS)	IMAG. (mS)
40	+206.5	-113.8	-202.6	+118.1	-0.20	-0.3	+0.2	+0.5
100	+104.3	-114.0	-96.4	+120.1	-0.40	-0.5	+0.4	+0.9
200	+53.1	-81.1	-41.7	+87.7	-0.50	-0.7	+0.6	+1.4
300	+35.9	-62.1	-22.0	+68.6	-0.60	-0.8	+0.7	+2.0
400	+28.1	-50.0	-12.5	+56.9	-0.60	-1.1	+0.8	+2.5
500	+23.4	-42.3	-6.1	+48.2	-0.60	-1.3	+0.8	+3.1
600	+20.1	-36.4	-1.2	+41.6	-0.60	-1.5	+0.9	+3.6
700	+18.2	-32.0	+2.0	+36.7	-0.60	-1.7	+1.0	+4.2
800	+16.2	-28.2	+4.5	+31.3	-0.60	-1.9	+1.1	+4.7
900	+15.5	-25.7	+6.5	+28.1	-0.60	-2.1	+1.3	+5.3
1000	+14.7	-23.5	+7.9	+24.9	-0.60	-2.3	+1.4	+5.9

8. Package outline

Plastic surface mounted package; 3 leads

SOT23

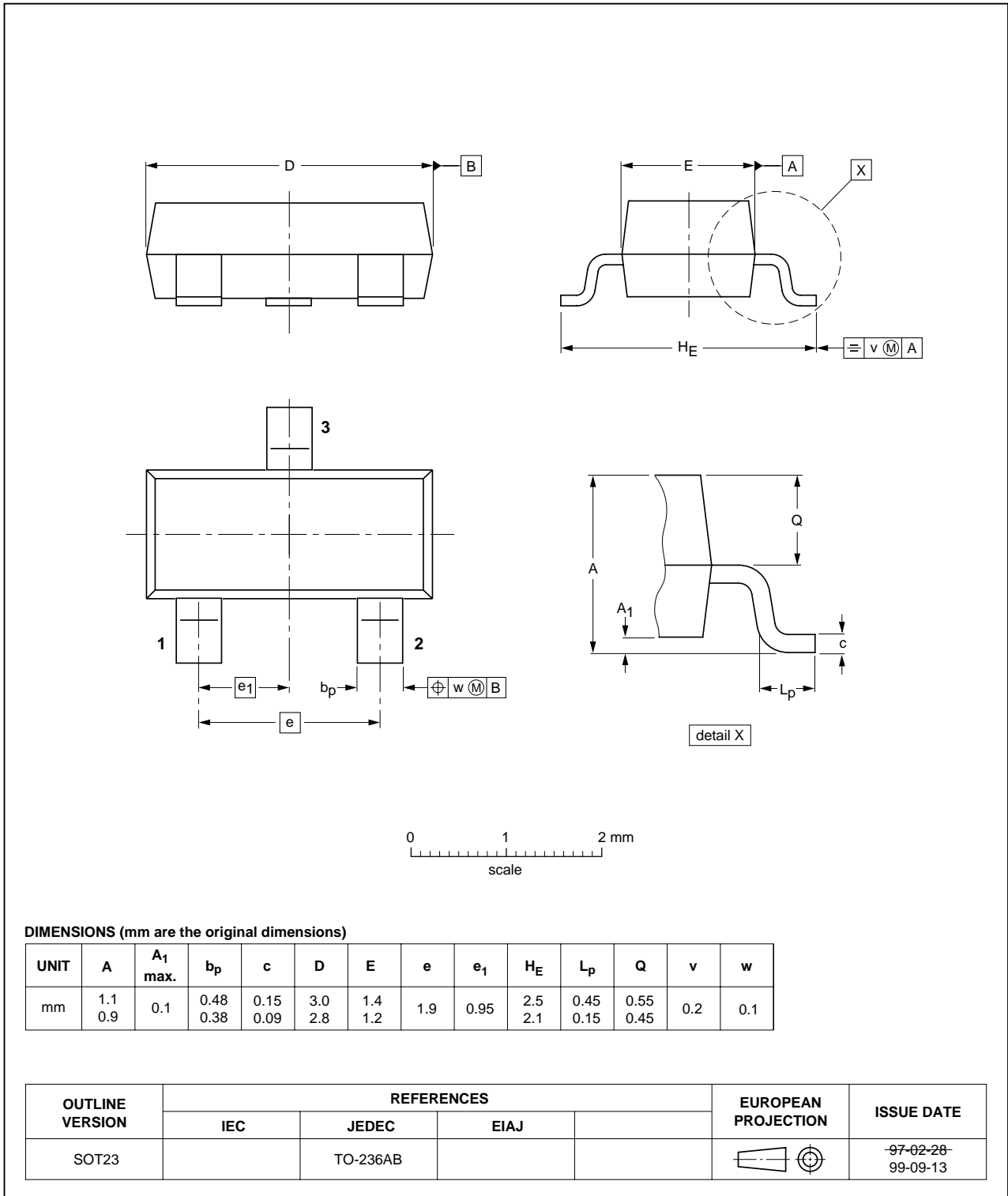

Fig 17. Package outline.

9. Revision history

Table 12: Revision history

Document ID	Release date	Data sheet status	Change notice	Order number	Supersedes
BF547_3	20040727	Product data sheet	-	9397 750 13392	BF547_2
Modifications:	<ul style="list-style-type: none">Marking code changed; see Table 4				

10. Data sheet status

Level	Data sheet status ^[1]	Product status ^[2] ^[3]	Definition
I	Objective data	Development	This data sheet contains data from the objective specification for product development. Philips Semiconductors reserves the right to change the specification in any manner without notice.
II	Preliminary data	Qualification	This data sheet contains data from the preliminary specification. Supplementary data will be published at a later date. Philips Semiconductors reserves the right to change the specification without notice, in order to improve the design and supply the best possible product.
III	Product data	Production	This data sheet contains data from the product specification. Philips Semiconductors reserves the right to make changes at any time in order to improve the design, manufacturing and supply. Relevant changes will be communicated via a Customer Product/Process Change Notification (CPCN).

[1] Please consult the most recently issued data sheet before initiating or completing a design.

[2] The product status of the device(s) described in this data sheet may have changed since this data sheet was published. The latest information is available on the Internet at URL <http://www.semiconductors.philips.com>.

[3] For data sheets describing multiple type numbers, the highest-level product status determines the data sheet status.

11. Definitions

Short-form specification — The data in a short-form specification is extracted from a full data sheet with the same type number and title. For detailed information see the relevant data sheet or data handbook.

Limiting values definition — Limiting values given are in accordance with the Absolute Maximum Rating System (IEC 60134). Stress above one or more of the limiting values may cause permanent damage to the device. These are stress ratings only and operation of the device at these or at any other conditions above those given in the Characteristics sections of the specification is not implied. Exposure to limiting values for extended periods may affect device reliability.

Application information — Applications that are described herein for any of these products are for illustrative purposes only. Philips Semiconductors make no representation or warranty that such applications will be suitable for the specified use without further testing or modification.

12. Disclaimers

Life support — These products are not designed for use in life support appliances, devices, or systems where malfunction of these products can reasonably be expected to result in personal injury. Philips Semiconductors customers using or selling these products for use in such applications do so at their own risk and agree to fully indemnify Philips Semiconductors for any damages resulting from such application.

Right to make changes — Philips Semiconductors reserves the right to make changes in the products - including circuits, standard cells, and/or software - described or contained herein in order to improve design and/or performance. When the product is in full production (status 'Production'), relevant changes will be communicated via a Customer Product/Process Change Notification (CPCN). Philips Semiconductors assumes no responsibility or liability for the use of any of these products, conveys no license or title under any patent, copyright, or mask work right to these products, and makes no representations or warranties that these products are free from patent, copyright, or mask work right infringement, unless otherwise specified.

13. Contact information

For additional information, please visit: <http://www.semiconductors.philips.com>

For sales office addresses, send an email to: sales.addresses@www.semiconductors.philips.com

14. Contents

1	Product profile	1
1.1	General description	1
1.2	Features	1
1.3	Applications	1
1.4	Quick reference data	1
2	Pinning information	2
3	Ordering information	2
4	Marking	2
5	Limiting values	2
6	Thermal characteristics	3
7	Characteristics	3
8	Package outline	12
9	Revision history	13
10	Data sheet status	14
11	Definitions	14
12	Disclaimers	14
13	Contact information	14



© Koninklijke Philips Electronics N.V. 2004

All rights are reserved. Reproduction in whole or in part is prohibited without the prior written consent of the copyright owner. The information presented in this document does not form part of any quotation or contract, is believed to be accurate and reliable and may be changed without notice. No liability will be accepted by the publisher for any consequence of its use. Publication thereof does not convey nor imply any license under patent- or other industrial or intellectual property rights.

Date of release: 27 July 2004
Document order number: 9397 750 13392

Published in The Netherlands